



DC220-6 DEEP CYCLE

220AH @ 20Hr
6-Volt

Group Size: 27 (6V)

Maintenance-Free
Sealed AGM Battery

CYCLING CAPACITY

20 Hour Rate **220 Amp Hours**

RESERVE CAPACITY

Reserve @25 AMPS **425 Minutes**

Reserve @75 AMPS **112 Minutes**

ELECTRICAL SPECIFICATIONS

| | |
|---------------------|------------------|
| Nominal Voltage | 6 Volt |
| C100 | 242AH |
| C20 | 220AH |
| C10 | 198AH |
| C5 | 180AH |
| CCA | 990 |
| CA or MCA | 1170 |
| HPCA | 2000 Amps |
| Internal Resistance | 1.5m Ω |

MECHANICAL SPECIFICATIONS

| | | |
|----------------------|--|----------------|
| Group Size | 27 | |
| Terminal Type | M8 | |
| Terminal Torque | See reverse side | |
| Height (w/ terminal) | 8.90" | 226mm |
| Height (case only) | 8.66" | 220mm |
| Width | 6.85" | 174mm |
| Length | 12.05" | 306mm |
| Weight | 72.09 lbs. | 32.7 kg |
| Case Type | ABS Plastic - Flame Res. Rating UL94-HB | |

DISCHARGE TABLE (Constant Current)

| Time | Amps | Rate |
|------|------|--------|
| 20hr | 11.0 | 0.05CA |
| 10hr | 19.8 | 0.10CA |
| 8hr | 23.9 | 0.13CA |
| 5hr | 36.0 | 0.25CA |
| 3hr | 49.8 | 0.33CA |
| 2hr | 67.3 | 0.50CA |
| 1hr | 125 | 1.00CA |

DISCHARGE PROFILE (Constant Current)

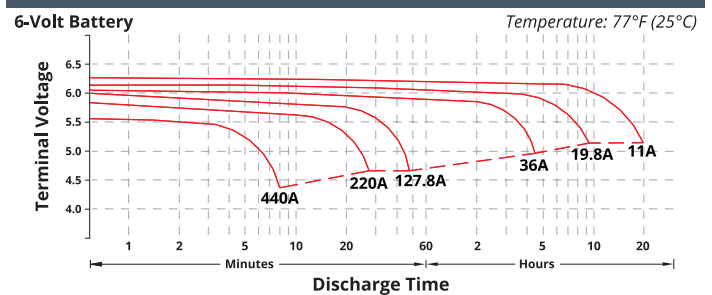

- All listed ratings are @ 100% SoC, T=77°F (25°C), 1.75VPC unless otherwise specified.

- Specifications listed are for estimation purposes only. Battery performance can vary depending on application. Battery design subject to change.

BATTERY & TERMINAL DIMENSIONS (All units shown in mm)

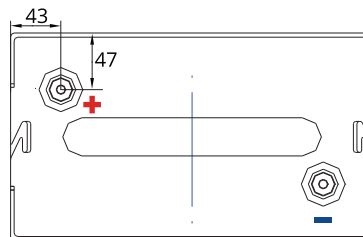
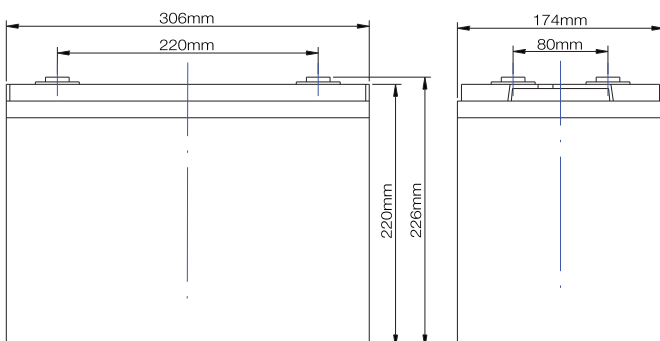

Battery bank spacing required,
12.5mm (1/2" inch) minimum

Terminal: M8

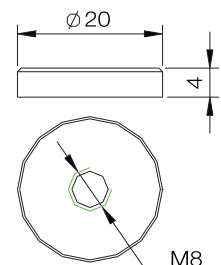

(unit: mm)



DC220-6 DATA SHEET

fullriverbattery.com

TEMPERATURE vs CAPACITY



STATE of CHARGE (SOC) vs OPEN CIRCUIT VOLTAGE (OCV)

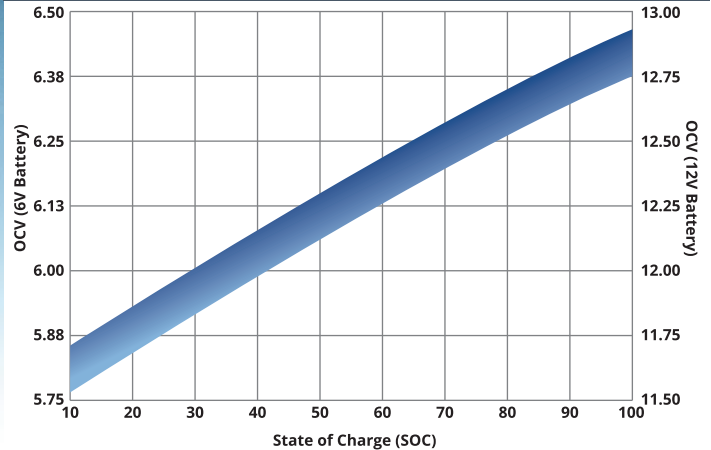

CYCLE LIFE vs DEPTH of DISCHARGE (DOD)

*(Based on BCI Testing @ 2-hr Rate)

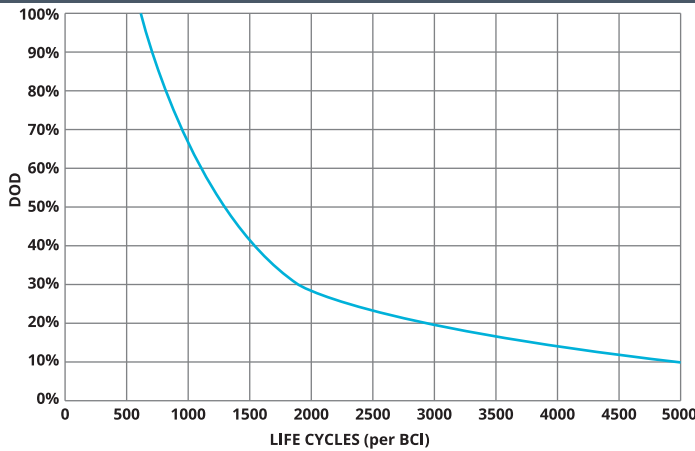

SELF DISCHARGE vs TIME/TEMPERATURE

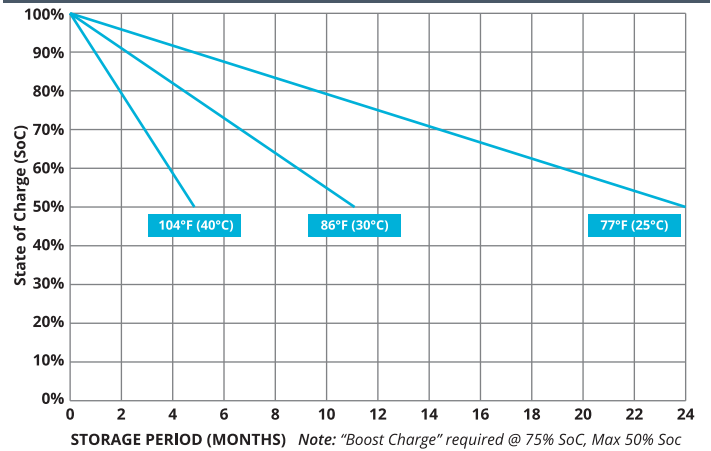

TEMPERATURE RANGE SPECIFICATIONS

| Condition | Recommended | Maximum | Recommended | Maximum |
|----------------|---------------|----------------|---------------|---------------|
| Storage | 5°F to 122°F | -40°F to 160°F | -15°C to 50°C | -40°C to 71°C |
| Operation | 5°F to 104°F | -40°F to 160°F | -15°C to 40°C | -40°C to 71°C |
| Charge with TC | 5°F to 122°F | -40°F to 160°F | -15°C to 50°C | -40°C to 71°C |
| Charge w/o TC | 32°F to 104°F | 5°F to 122°F | 0°C to 40°C | -15°C to 50°C |

*TC= Temperature Compensation

CHARGE VOLTAGES

| Charge Stage | Battery Voltages | | | |
|--------------|------------------|-------|-------|-------|
| | 12V | 24V | 36V | 48V |
| Bulk | 14.7V | 29.4V | 44.1V | 58.8V |
| Absorption | 14.7V | 29.4V | 44.1V | 58.8V |
| Float | 13.6V | 27.2V | 40.8V | 54.6V |

TC Factor: (-2mV°F/cell) or (-4mV°C/cell)

TERMINAL TORQUE SPECS

| Terminal Type | ft-lbs | in-lbs | Nm |
|---|------------|---------|------------|
| AP, DT (AP), M6, M6M (Stud), TP07 (AP), TP08 (AP) | 4.2 - 6.0 | 50-70 | 5.6 - 7.9 |
| FR45 | 6.0 - 7.5 | 70-90 | 7.9 - 10.1 |
| M8 | 7.1 - 8.0 | 85-95 | 9.6 - 10.7 |
| DT (Stud), M10M (Stud) | 9.2 - 10.4 | 110-125 | 12.2 - 14 |



9001:2008 Quality Management System
 14001:2004 Environmental Management System
 18001:2007 Occupational Health & Safety Management System



DELIVERY APPROVED!
**LAND, SEA
 & AIR**

Fullriver batteries are sealed lead acid batteries made with Absorbed Glass Mat (AGM) technology. The electrolyte is absorbed into the fiberglass separator material rather than in a free-flowing liquid form. Fullriver batteries are non-spillable electric storage batteries. They are excepted from the requirements of DOT's hazardous materials regulations, since they adhere to the requirements of code 49 CFR Section 173.159(D) - (CLASSIFIED APPROVED: DOT, CFR, HMR49, IATA, ICAO67, IMDG27)